

Microcystin-ADDA ELISA Kit, Detailed Procedure

1. Addition of Standards, Samples

Add 50 μL of the standard solutions, control, or samples into the wells of the test strips according to the working scheme given. We recommend using duplicates or triplicates.

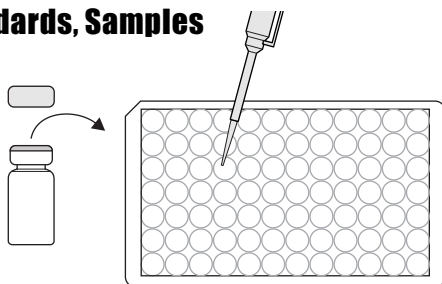

2. Addition of Antibody Solution

Add 50 μL of the antibody solution to the individual wells successively using a multi-channel pipette or a stepping pipette. Cover the wells with parafilm or tape and mix the contents by moving the strip holder in a rapid circular motion on the benchtop for 30 seconds. Be careful not to spill contents. Incubate for 90 minutes at room temperature.

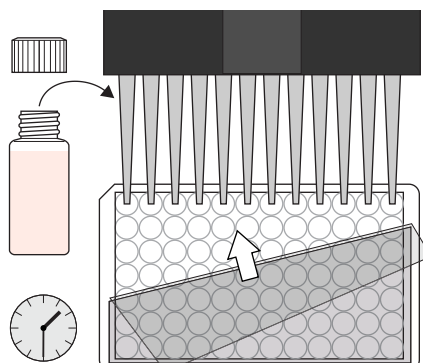

3. Washing of Plates

After incubation, remove the covering and vigorously shake the contents of the wells into a sink. Wash the strips three times with a multi-channel pipette using the 1X washing buffer solution. Please use at least a volume of 250 μL of washing buffer for each well and each washing step. Remaining buffer in the wells should be removed by patting the plate dry on a stack of paper towels.

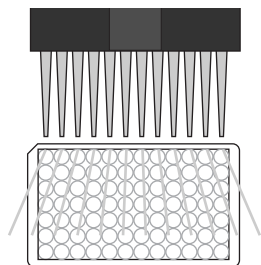

4. Addition of Enzyme Conjugate

Add 100 μL of enzyme conjugate solution to the individual wells successively using a multi-channel pipette or a stepping pipette. Cover the wells with parafilm or tape and mix the contents by moving the strip holder in a rapid circular motion on the benchtop. Incubate for 30 minutes at room temperature.

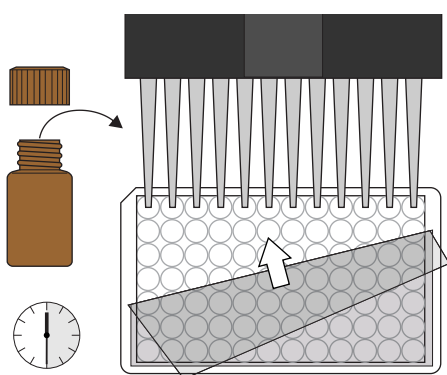

5. Washing of Plates

After incubation, remove the covering and vigorously shake the contents of the wells into a sink. Wash the strips three times with a multi-channel pipette using the 1X washing buffer solution. Please use at least a volume of 250 μL of washing buffer for each well and each washing step. Remaining buffer in the wells should be removed by patting the plate dry on a stack of paper towels.

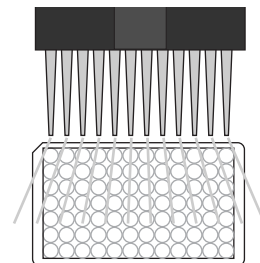

6. Addition of Substrate/Color Solution

Add 100 μL of substrate/color solution to the wells using a multi-channel pipette or a stepping pipette. The strips are incubated for 20-30 minutes at room temperature. Protect the strips from direct sunlight.

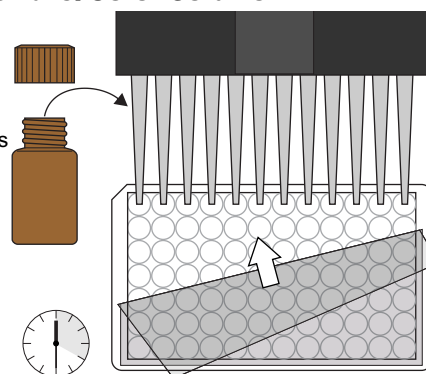

7. Addition of Stopping Solution

Add 50 μL of stop solution to the wells in the same sequence as for the substrate solution using a multi-channel pipette or a stepping pipette.

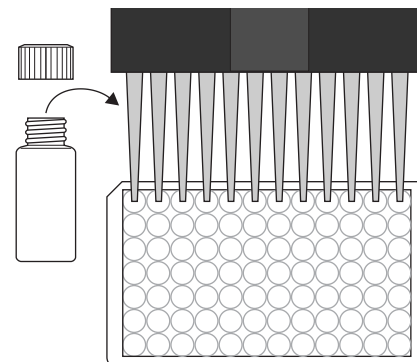

8. Measurement of Color

Read the absorbance at 450 nm using a microplate ELISA reader. Calculate results.

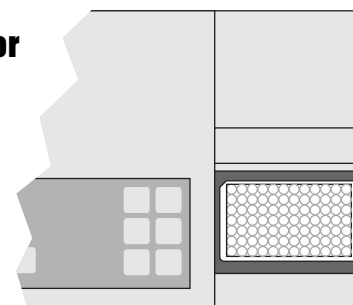

For Ordering or Technical Assistance Contact:
ABRAXIS, LLC
124 Railroad Drive, Warminster, PA 18974
Phone: 215-357-3911 Fax: 215-357-5232
www.abraxiskits.com

Microcystin-ADDA ELISA Kit, Concise Procedure

1. Addition of Standards, Samples

Add 50 μ L of the standard solutions, control, or samples.

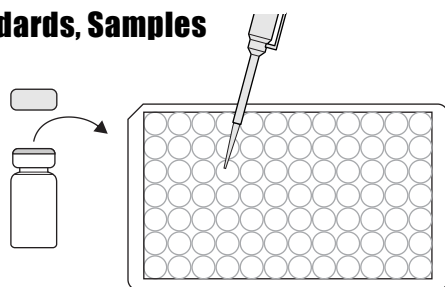

2. Addition of Antibody Solution

Add 50 μ L of the antibody solution. Cover and mix for 30 seconds by rotating on benchtop. Incubate for 90 minutes at room temperature.

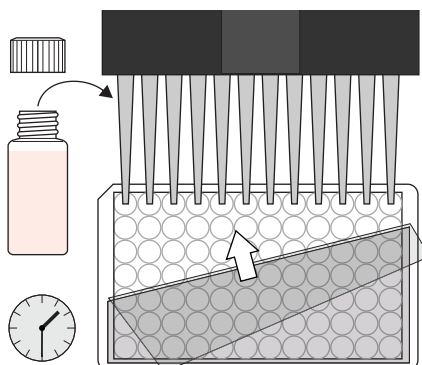

3. Washing of Plates

Wash plates three times with 250 μ L of 1X washing buffer.

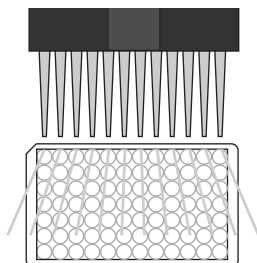

4. Addition of Enzyme Conjugate

Add 100 μ L of enzyme conjugate. Incubate for 30 minutes at room temperature.

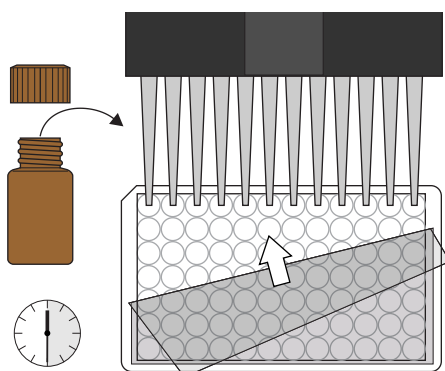

5. Washing of Plates

Wash plates three times with 250 μ L of 1X washing buffer.

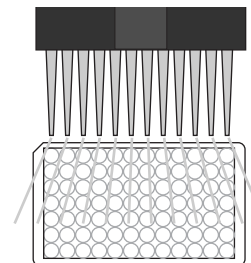

6. Addition of Substrate/Color Solution

Add 100 μ L of substrate/color solution. Incubate for 20-30 minutes at room temperature and away from direct sunlight.

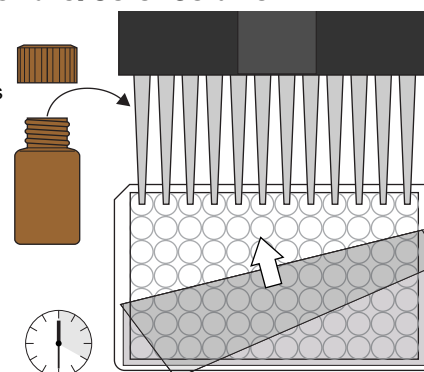

7. Addition of Stopping Solution

Add 50 μ L of stop solution.

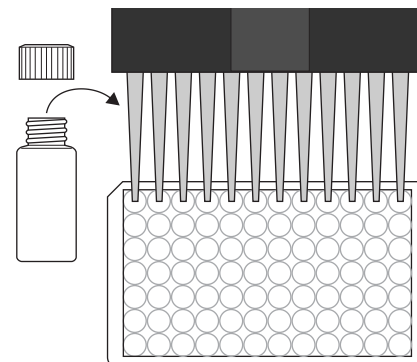

8. Measurement of Color

Measure color at 450 nm.
Calculate results.

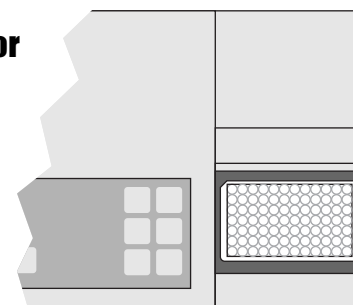

For Ordering or Technical Assistance Contact:
ABRAXIS, LLC
124 Railroad Drive, Warminster, PA 18974
Phone: 215-357-3911 Fax: 215-357-5232
www.abraxiskits.com